

# DESIGN OF MICROSTRIP ANTENNA FOR WIRELESS COMMUNICATION AT 2.4 GHZ

<sup>1,\*</sup>A.B. MUTIARA, <sup>2,\*</sup>R.REFIANTI, \*RACHMANSYAH

\*Faculty of Computer Science and Information Technology, Gunadarma University  
Jl. Margonda Raya No.100, Depok 16424, Indonesia

E-mail : <sup>1,2</sup>{amutiara,rina}@staff.gunadarma.ac.id

## ABSTRACT

The paper presents a broadband microstrip patch antenna for wireless communication. In its most basic form, a microstrip patch antenna consists of a radiating patch on one side of a dielectric substrate which has a ground plane on the other side. The patch is generally made of conducting material such as copper or gold and can take any possible shape. A rectangular patch is used as the main radiator. There are several advantages of this type of broadband antenna, such as planar, small in size, simple in structure, low in cost, and easy to be fabricated, thus attractive for practical applications. This rectangular microstrip patch antenna is designed for wireless communication application that works at 2.4 GHz with gain 11 dB for outdoor place. It also has a wide angle of beam in its radiation pattern. The results obtain that microstrip patch antenna can be used as client antenna in computer and workable antenna for wireless fidelity.

**Keywords:-** Microstrip Antenna, Wireless Fidelity, Frequency

## 1. INTRODUCTION

One of types of wireless communication at 2.4 GHz is Wireless Fidelity (WiFi). A WiFi enabled device such as a personal computer, video game console, smartphone or digital audio player can connect to the Internet when within range of a wireless network connected to the Internet [5]. The coverage of one or more (interconnected) access points (hotspot) can round up an area as small as a few rooms or as large as many square miles.

With the development of MIC and high frequency semiconductor devices, microstrip has drawn the maximum attention of the antenna community in recent years. In spite of its various attractive features like, light weight, low cost, easy fabrication, conformability on curved surface and so on, the microstrip element suffers from an inherent limitation of narrow impedance bandwidth.

## 2. METHODOLOGY ADAPTED

### A. Antenna Shape

In its most basic form, a Microstrip patch antenna consists of a radiating patch on one side of a dielectric substrate which has a ground plane on the other side as shown in Figure 1. The patch is generally made of conducting material such as

copper or gold and can take any possible shape. The radiating patch and the feed lines are usually photo etched on the dielectric substrate.

Microstrip patch antennas radiate primarily because of the fringing fields between the patch edge and the ground plane. For good antenna performance, a thick dielectric substrate having a low dielectric constant is desirable since this provides better efficiency, larger bandwidth and better radiation [8].

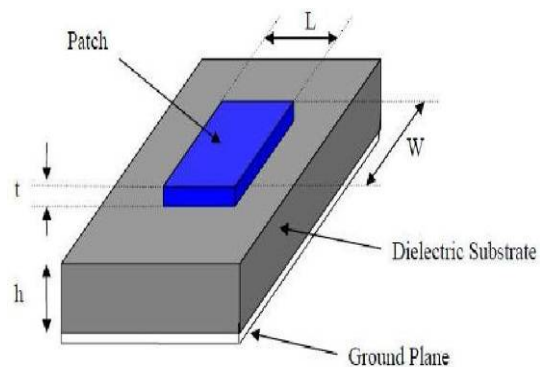

Fig. 1: Structure of Microstrip Patch Antenna [12]

### B. Method of Analysis

Transmission line model represents the microstrip antenna by two slots of width  $W$  and height  $h$ , separated by a transmission line of length  $L$ . The

microstrip is essentially a nonhomogeneous line of two dielectrics, typically the substrate and air.

In Figure 2, most of the electric field lines reside in the substrate and parts of some lines in air. As a result, this transmission line cannot support pure transverse electric- magnetic (TEM) mode of transmission, since the phase velocities would be different in the air and the substrate. Instead, the dominant mode of propagation would be the quasi-TEM mode. Hence, an effective dielectric constant ( $\epsilon_{\text{reff}}$ ) must be obtained in order to account for the fringing and the wave propagation in the line.

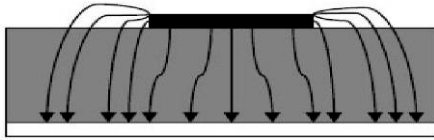

Figure 2: Electric Field Lines [12]

The value of ( $\epsilon_{\text{reff}}$ ) is slightly less than  $\epsilon_r$  because the fringing fields around the periphery of the patch are not confined in the dielectric substrate but are also spread in the air as shown in Figure 2 above.

$$\epsilon_{\text{reff}} = \frac{\epsilon_r + 1}{2} + \frac{\epsilon_r - 1}{2} \left[ 1 + 12 \frac{h}{W} \right]^{-\frac{1}{2}} \quad (1)$$

where,

- $\epsilon_{\text{reff}}$  = Effective dielectric constant
- $\epsilon_r$  = Dielectric constant of substrate
- $h$  = Height of dielectric substrate
- $W$  = Width of the patch

Consider Figure 3 below, which shows a rectangular microstrip patch antenna of length  $L$ , width  $W$  resting on a substrate of height  $h$ . The co-ordinate axis is selected such that the length is along the  $x$  direction, width is along the  $y$  direction and the height is along the  $z$  direction.

In order to operate in the fundamental  $TM_{10}$  mode, the length of the patch must be slightly less than  $\lambda/2$  where  $\lambda$  is the wavelength in the dielectric medium and is equal to  $\lambda_0/\sqrt{\epsilon_{\text{reff}}}$  where  $\lambda_0$  is the free space wavelength. The  $TM_{10}$  mode implies that the field varies one  $\lambda/2$  cycle along the length, and there is no variation along the width of the patch. In the Figure 4 shown below, the microstrip patch antenna is represented by two slots, separated by a transmission line of length  $L$  and open circuited at both the ends. Along the width of the patch, the voltage is maximum

and current is minimum due to the open ends. The fields at the edges can be resolved into normal and tangential components with respect to the ground plane.

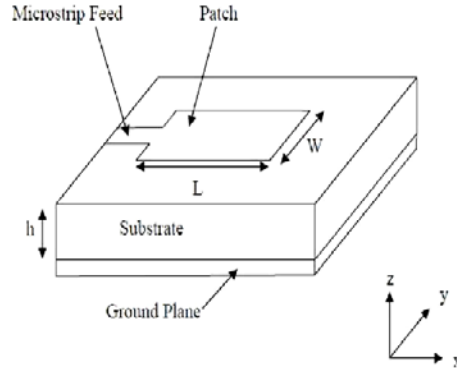

Figure 3: Microstrip Patch Antenna [12]

It is seen from Figure 5 that the normal components of the electric field at the two edges along the width are in opposite directions and thus out of phase since the patch is  $\lambda/2$  long and hence they cancel each other in the broadside direction. The tangential components (seen in Figure 5), which are in phase, means that the resulting fields combine to give maximum radiated field normal to the surface of the structure. Hence the edges along the width can be represented as two radiating slots, which are  $\lambda/2$  apart and excited in phase and radiating in the half space above the ground plane. The fringing fields along the width can be modeled as radiating slots and electrically the patch of the microstrip antenna looks greater than its physical dimensions. The dimensions of the patch along its length have now been extended on each end by a distance  $\Delta L$ .

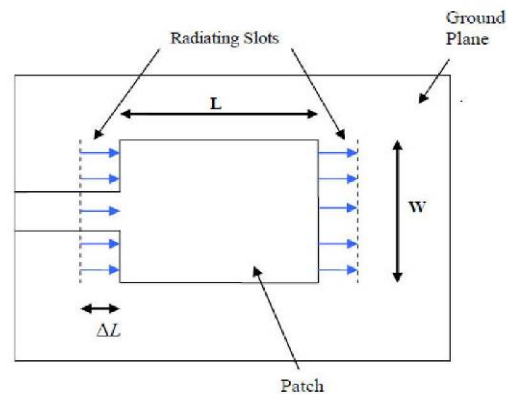

Figure 4: Top View of Antenna [12]

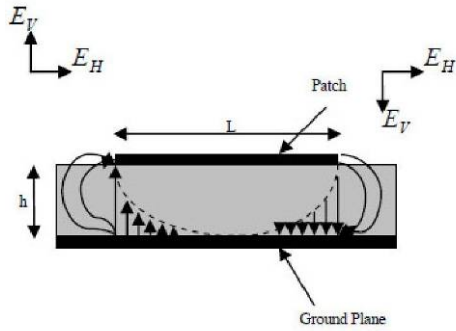

Figure 5: Side View of Antenna [12]

$$\Delta L = 0.412 \frac{(\epsilon_{\text{reff}} \pm 0.3) \left( \frac{W}{h} + 0.264 \right)}{(\epsilon_{\text{reff}} - 0.258) \left( \frac{W}{h} + 0.8 \right)} \quad (2)$$

The effective length of the patch  $L_{\text{eff}}$  now becomes:

$$L_{\text{eff}} = L + 2\Delta L \quad (3)$$

For a given resonance frequency  $f_0$ , the effective length is

$$L_{\text{eff}} = \frac{c}{2f_0 \sqrt{\epsilon_{\text{reff}}}} \quad (4)$$

For a rectangular Microstrip patch antenna, the resonance frequency for any  $TM_{mn}$  mode is

$$f_0 = \frac{c}{2\sqrt{\epsilon_{\text{reff}}}} \left[ \left( \frac{m}{L} \right)^2 + \left( \frac{n}{W} \right)^2 \right]^{\frac{1}{2}} \quad (5)$$

where  $m$  and  $n$  are modes along  $L$  and  $W$  respectively.

For efficient radiation, the width  $W$  is

$$W = \frac{c}{2f_0 \sqrt{\frac{(\epsilon_r + 1)}{2}}} \quad (6)$$

### C. Feed Point

The Coaxial feed or probe feed is a very common technique used for feeding Microstrip patch antennas. As seen from Figure 6, the inner conductor of the coaxial connector extends through the dielectric and is soldered to the radiating patch, while the outer conductor is connected to the ground plane. The feed co-ordinates were calculated  $Y_f = W/2$  and  $X_f = X_0 - \Delta L$  where,

$$X_0 = \frac{L}{\pi} \cos^{-1} \sqrt{\frac{50}{Z_0}} \quad (7)$$

$$Z_0 = \sqrt{50 \times Z_{in}} \quad (8)$$

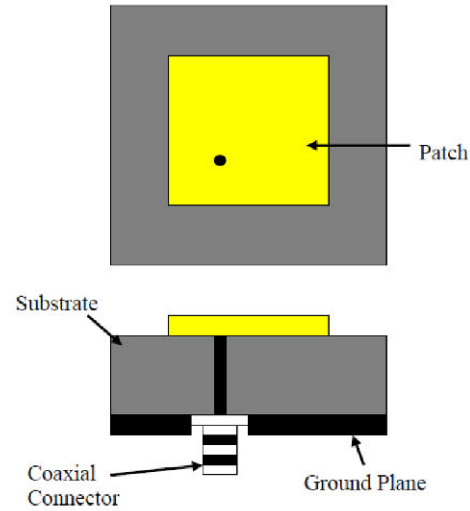

Figure 6: Coaxial Feed [12]

The main advantage of this type of feeding scheme is that the feed can be placed at any desired location inside the patch in order to match with its input impedance. This feed method is easy to fabricate and has low spurious radiation. However, its major disadvantage is that it provides narrow bandwidth and is difficult to model since a hole has to be drilled in the substrate and the connector protrudes outside the ground plane, thus not making it completely planar for thick substrates ( $h > 0.02 \lambda_0$ ). Also, for thicker substrates, the increased probe length makes the input impedance more inductive, leading to matching problems. It is seen above that for a thick dielectric substrate, which provides broad bandwidth, the microstrip line feed and the coaxial feed suffer from numerous disadvantages. The non-contacting feed techniques which have been discussed below, solve these problems.

### D. Dielectric Substrate

Considering the trade-off between the antenna dimensions and its performance, it was found suitable to select a thin dielectric substrate with low dielectric constant. Thin substrate permits to reduce the size and also spurious radiation as surface wave, and low dielectric constant – for higher bandwidth, better efficiency and low power loss. The simulated results were found satisfactory.

### E. Software for Simulation

The software used to model and simulate the Microstrip patch antenna was SuperNEC and 4NEC2X. SuperNEC is an Method of Moments electromagnetic (EM) simulation package for

Windows or Linux platforms. The easy to use 3D input GUI, making use of multi-level assemblies, provides the easiest ever structure input and model creation tool. The output viewer provides the design engineer with all the necessary information for proper antenna analysis including features such as 3D & 2D pattern plots, smith chart plots with network analyzer style markers, Coupling plots, Efficiency plots.

4NEC2 is a completely free Nec2, Nec4 and windows based tool for creating, viewing, optimizing and checking 2D and 3D style antenna geometry structures and generate, display and/or compare near/far-field radiation patterns for both the starting and experienced antenna modeler.

### 3. DESIGN ANALYSIS

#### A. Design Specification

The three essential parameters for the design of a rectangular Microstrip Patch Antenna are:

- Frequency of Operation

The resonant frequency of the antenna must be selected appropriately. The resonant frequency selected for my design is 2.4 GHz.

- Dielectric constant of the substrate ( $\epsilon_r$ )

The dielectric material selected for my design is styrofoam which has a dielectric constant of 1.03.

- Height of dielectric substrate ( $h$ )

Because of using styrofoam, so height of dielectric substrate is 12 mm.

So, the essential parameters for the design are :

- $f_0$  : 2.4 GHz
- $\epsilon_r$ : 1.03
- $h$  : 12 mm

#### B. Design Procedure

The transmission line model described in Section 2 will be used to design the antenna.

- Calculation the wavelength ( $\lambda$ )

Because  $c = 3 \times 10^8$  and  $f_0 = 2.4$  GHz,

$$\text{So } \lambda = c/f_0 \text{ ,}$$

By substituting  $c = 3 \times 10^8$  and  $f_0 = 2.4$  GHz., we get

$$\lambda = 0.125m = 125mm$$

- Calculation of the Width ( $W$ )

The width of the Microstrip patch antenna is given by equation (6) with substituting  $\epsilon_r = 1.03$ , we get

$$W = 62.04mm$$

- Calculation of Effective dielectric constant ( $\epsilon_{reff}$ )

Equation (1) gives the effective dielectric constant, with substituting  $h = 12mm$  and  $W = 62.04$ , we get

$$\epsilon_{reff} = 1.023$$

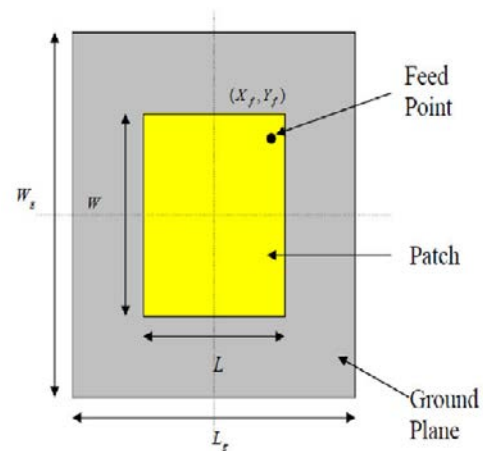

Figure 7: Top View of Design Procedure Microstrip Patch Antenna [12]

- Calculation of the Effective length ( $L_{eff}$ )
- Equation (4) gives the effective length, with substituting  $\epsilon_{reff} = 1.023$ , we get

$$L_{eff} = 61.79mm$$

- Calculation of the length extension ( $\Delta L$ )
- Equation (2) gives the length extension of antenna, with substituting  $L_{eff} = 61.79mm$ , we get

$$\Delta L = 7.78mm$$

- Calculation of actual length of patch ( $L$ )
- Equation (3) gives the actual length of patch, with substituting  $L_{eff} = 61.79mm$  and  $\Delta L = 7.78mm$ , we get

$$L = 46.23mm$$

- Calculation of the ground plane dimensions ( $L_{(g)}$  and  $W_{(g)}$ )

The transmission line model is applicable to infinite ground planes only. However, for



practical considerations, it is essential to have a finite ground plane. Finite and infinite ground plane can be obtained if the size of the ground plane is greater than the patch dimensions by approximately six times the substrate thickness all around the periphery. Hence, for this design, the ground plane dimensions would be given as:

$$L_{(g)} = 6h + L = 6(12) + 46.23 \text{ mm} = 118.23 \text{ mm}$$

$$W_{(g)} = 6h + W = 6(12) + 62.04 \text{ mm} = 134.04 \text{ mm}$$

• Input Impedance

The typical impedance at the edge of a resonant rectangular patch can be approximated as

$$Z_{in} = 90 \frac{\epsilon_r^2}{\epsilon_r - 1} \left( \frac{L}{W} \right)^2 \quad (9)$$

By equation (9), we get  $Z_{in} = 1776 \Omega$  which does not match well with a  $50 \Omega$  standard microstrip. By equation (8), the characteristic impedance of the transition section should be  $297 \Omega$

• Feed Point Locations ( $X_f Y_f$ )

A coaxial probe type feed is to be used in this design. As shown in Figure 7, the center of the patch is taken as the origin and the feed point location is given by the co-ordinates ( $X_f Y_f$ ) from the origin. The feed point must be located at that point on the patch, where the input impedance is  $50 \Omega$  for the resonant frequency.

The calculated feed coordinates for the given rectangular patch operating at 2.4 GHz are  $Y_f = 31.02 \text{ mm}$  and  $X_f = 9.11 \text{ mm}$ . But this equation is an approximation and will only provide the starting point. It is very much an iterative process, to work out the exact co-ordinates that will match the impedance of the feedline to the antenna. Hence, a trial and error method is used to locate the feed point.

Table .1: Feed Point Trial Error

No	Feed Location ( $X_f, Y_f$ ) (cm)	Input Impedance ( $Z_{in}$ ) ( $\Omega$ )
1	(0.9,3.1)	41.6+j39.5
2	(1,2)	44.2+j43.7
3	(1.1,2)	50.5+j42.1
4	(2,1)	74.8+j29.1
5	(2,2)	78+j19.1

From table 1, feed point that closer to  $50 \Omega$  is (1.1,2) and the input impedance  $50.5+j42.1$

C. Simulation Setup

The softwares used to design and simulate the microstrip patch antenna are SUPERNEC and 4NEC2X.

SuperNEC is a Method of Moments electromagnetic (EM) simulation package for windows or Linux platform. The easy to use 3D input GUI, making use of multilevel assemblies, provides the easiest ever structure input and model creation tool [3]. The output viewer provides the design engineer with all necessary information for proper antenna analysis including features such as 3D and 2D pattern plots, smith chart plot with network analyzer style marker, coupling plots, efficiency plots etc.

4NEC2X is a completely free Nec2, Nec4 and windows based tool for creating, viewing, optimizing and checking 2D and 3D style antenna geometry structures and generate, display and/ or compare near/far-field radiation pattern for both the starting and experienced antenna modeler [1].

1. Radiation Pattern and Gain

Radiation pattern and gain of microstrip patch antenna as shown in Figure 8. This figure represented by MATLAB simulation and informs gain about 8.6 dBi.

2. 3D Structure Microstrip Patch Antenna

Structure of microstrip patch antenna in 3D is shown in Figure 9. This figure represented by 4Nec2X. The wires are on the top as patch, on the bottom as ground plane and between those wires as substrate. Feed point represented by circle purple.

3. Far-Field Radiation Pattern

In figure 10, the radiation pattern of microstrip antenna has a back lobe. In figure can be seen also the maximum value of signal strength captured by the antenna is 8.55 dB, which located at  $15^\circ$ . Points where the receiver is down by half from its maximum value (-3dB) is 5.55 dB, which located at position  $335^\circ$  and  $45^\circ$ . From the position where the receptivity decreased by -3dB antenna, we can determine the half power beamwidth of the microstrip antenna which is  $70^\circ$ .

4. Smith Chart



Smith Chart of microstrip patch antenna simulation as shown in figure 11 with impedance input  $50.5+j42.1$ .

involving central access points (including those built in to broadband wireless routers).

A computer is used as a produce of wireless signals, while other computers installed microstrip patch antenna as of omnidirectional antenna. In wireless card will be used as testing of microstrip patch antenna radiation pattern by detecting the signal strength of wireless signal sources.

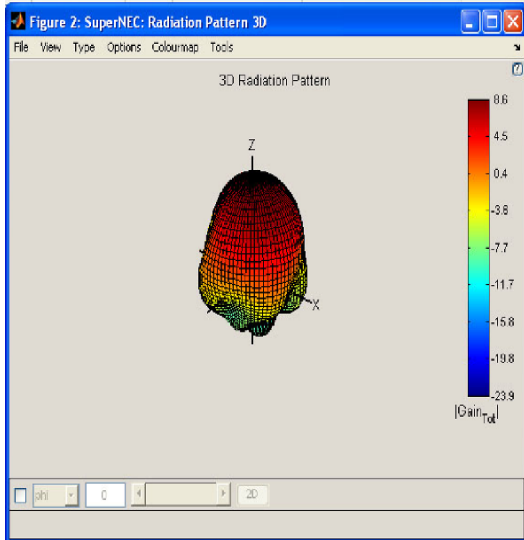

Figure 8: 3D Radiation Pattern

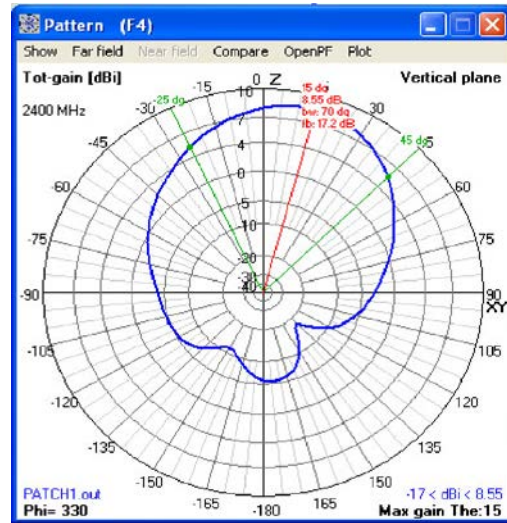

Figure 10: Radiation Pattern of Vertical Plane

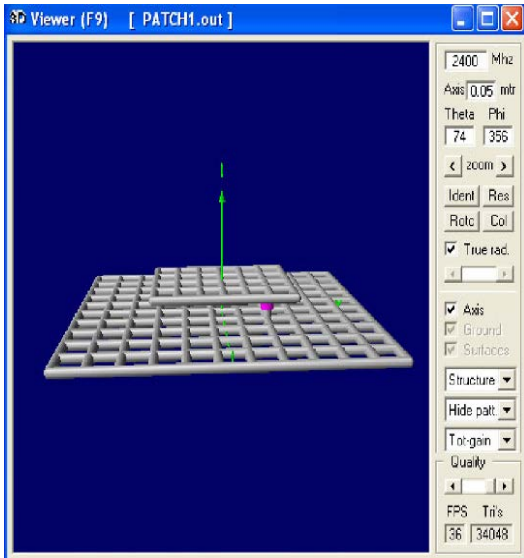

Figure 9: 3D Structure Microstrip Patch Antenna

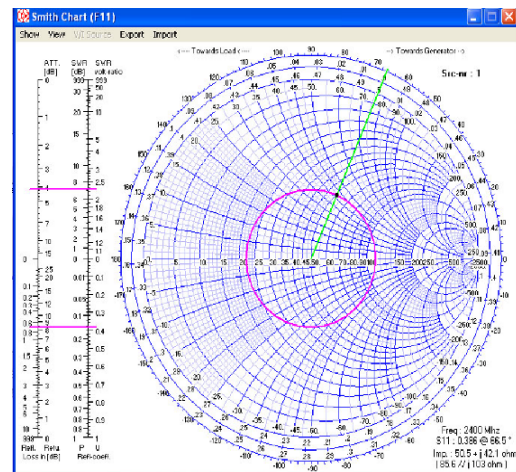

Figure 11: Smith Chart

#### 4. TESTING AND RESULTS

In testing, microstrip patch antenna is used as a substitute for external omnidirectional antenna from wireless LAN card in Ad-hoc mode. In a wireless computer network, ad-hoc mode is a method for wireless devices to directly communicate with each other. Operating in ad-hoc mode allows all wireless devices within range of each other to discover and communicate in peer-to-peer fashion without

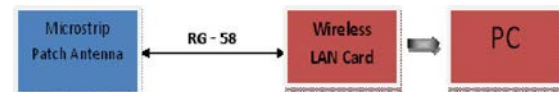

Figure 12: Block Diagram of microstrip patch antenna as of omnidirectional antenna

Microstrip patch antenna is connected to the wireless LAN card in the computer via cable RG-58 which has a characteristic impedance of  $50\Omega$ . In

implementation, microstrip patch antenna and wireless LAN card are connected as shown figure 13. Signal strength of wireless LAN captured by the microstrip antenna is shown on the computer. The strongest signal decided as position 0°.

Signal strength information is recorded in the table. After that, the microstrip patch antenna is shifted by 5°, and then the signal strength is displayed on the computer recorded back in the table. This is done repeatedly for every different angle to 360°.

When omnidirectional antennas are connected to the wireless LAN card, we obtained by the same signal strength to all direction of -50 dBm. If the data in the table plotted in polar coordinates, it will be obtained microstrip patch antenna radiation pattern of microstrip patch antenna. Radiation pattern of microstrip patch antenna can be seen in Figure 14.

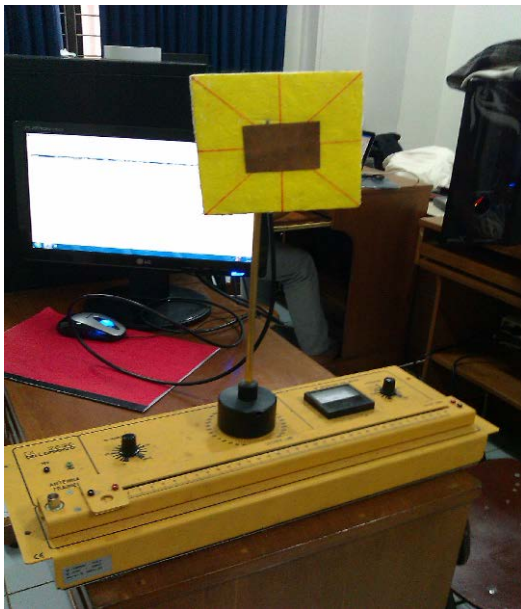

Figure 13: Microstrip Patch Antenna for 2.4 GHz

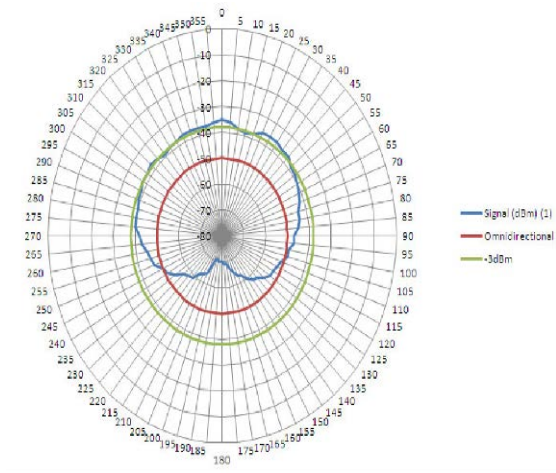

Figure 14: Indoor Radiation Pattern

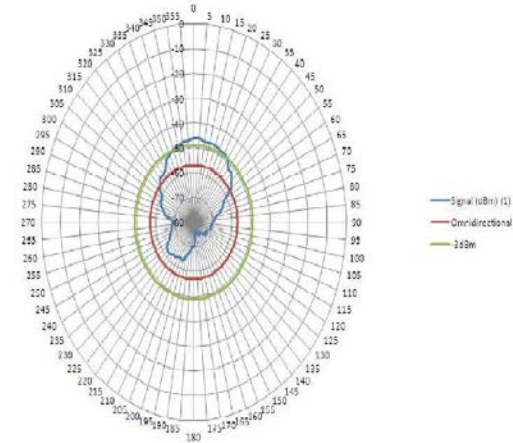

Figure 15: Outdoor Radiation Pattern

From figure 14, blue lines represent radiation pattern of microstrip patch antenna, the red line represents radiation pattern of the omnidirectional antenna, the green line represents the value of -3dB of microstrip patch antenna. In the figure, also show maximum signal strength of wireless LAN signals captured by the microstrip antenna of -35 dBm at an angle 0°. The signal strength decreased (-3 dBm) of -38 dBm at an angle of 330° and point 10° (point of intersection between the blue lines and green lines). Half Power Beamwidth of microstrip patch antenna is 40°. There is still back lobe in radiation pattern of microstrip antenna.

From Figure 15, the maximum signal strength of wireless LAN signals captured by the microstrip antenna of -46 dBm at an angle 0°. The signal strength decreased (-3 dBm) of -49 dBm at an angle of 340° and point 10° (point of intersection between



the blue lines and green lines). Half Power Beamwidth of microstrip patch antenna is 30°. There is still back lobe in radiation pattern of microstrip antenna.

## 5. CONCLUSIONS

The designing and manufacturing microstrip patch antenna has been accomplished. A number of findings have been identified during the designing and manufacturing phases as follows,

- The signal strength (Gain) of microstrip patch antenna compared with omnidirectional antenna (TL-WN350GD) are 15 dB for indoor place and 11 dB for outdoor place.
- The radius of microstrip patch antenna is about ±200m.
- The Half Power Beamwidth of microstrip patch antenna are 40o for indoor place and 30o for outdoor place.
- There is still back lobe in radiation pattern of microstrip antenna.
- Microstrip patch antenna can be used as client antenna in computer

## ACKNOWLEDGMENT

Authors would like to thank to Gunadarma Foundations for financial support.

## REFERENCES

[1] 4nec. <http://home.ict.nl/arivoors/>.

[2] The antenna tutorial website.

<http://www.antenna-theory.com/antennas>.

[3] Super nec. <http://www.super nec.com/>.

[4] What is wireless ad-hoc mode?  
<http://compnetworking.about.com/cs/wirelessfaq/>

[5] Wi-fi. <http://en.wikipedia.org/wiki/Wi-Fi>.

[6] Wireless. <http://en.wikipedia.org/wiki/Wireless>

[7] Wirelesslan. [http://en.wikipedia.org/wiki/Wireless\\_LAN](http://en.wikipedia.org/wiki/Wireless_LAN)

[8] Constantine A. Balanis. *Antennas Theory - Analysis and Design*. 3<sup>rd</sup> Edition. John Wiley&Sons, Inc, 1997.

[9] Yi Huang and Kevin Boyle. *Antennas from Theory to Practice*. John Wiley&Sons, Inc, 2008.

[10] John D. Kraus. *Antennas*. 2nd Edition. McGraw Hill International, 1988.

[11] S.N Makarov. *Antenna and EM Modeling with MATLAB*. John Wiley&Sons, Inc, 2002.

[12] Punit S. Nakar. Design of a compact microstrip patch antenna for use in wireless/cellular devices. Master's thesis, The Florida State University, 2004.

[13] Sophocles J. Orfanidis. *Electromagnetic Waves and Antennas*. Rutgers University, 2008.

[14] W.L Stutzman and G.A Thiele. *Antenna Theory and Design*. John Wiley&Sons, Inc, 1998.

[15] F.T Ulaby. *Fundamentals of Applied Electromagnetics*. Prentice Hall, 1999.

[16] Dr.John L. Volakis. *Antenna Engineering Handbook*. 4th Edition. McGraw Hill, 2007.

[17] Kin-Lu Wong. *Compact and Broadband Microstrip Antennas*. John Wiley&Sons, Inc, 2002.





**AUTHOR PROFILES:**



**Rachmansyah** was born in Depok, Indonesia, in 1989. He received B.S degree in Electrical Engineering from Gunadarma University, Indonesia, in 2010. His current interests are wireless communication and image processing. Now he still studies in Magister Electrical Engineering from Gunadarma University, Indonesia.



**Achmad Benny Mutiara** was born in Jakarta, in 1967, and is a professor of computer science at Gunadarma University. He received the B.S degree in Dept. of Physics from University of Indonesia and Dept. of Informatics Engineering from Gunadarma University, Indonesia, in 1991. He also received the M.S and PhD degrees in Computation from Universitaet Goettingen, Germany, in 1996 and 2000, respectively. He is Dean, Faculty of Computer Science and Information Technology at Gunadarma University. His current interests are Computer Modeling and Simulation (esp. Molecular Dynamics Simulation and Monte Carlo), parallel computing (PC-Clustering), and Computational Science.

**Rina Refianti** is with Faculty of Computer Science and Information Technology at Gunadarma University. She received the B.S. and M.S. degree in Dept of Information system from Gunadarma University, in 1991 and 2003, respectively.