

ANALYSIS AND REDUCTION OF TIME SHIFT BETWEEN SENDING AND RECEIVING ON DATA ACQUISITION USING SMS GATEWAY SYSTEM

¹*WARSITO, ¹GURUM A. PAUZI, ¹AMIR SUPRIYANTO, ¹BERLI L. PUTRA, ²LAZUARDI UMAR, ¹SW. SUCIYATI

¹Department of Physics, Faculty of Mathematics and Natural Sciences,
University of Lampung, Bandar Lampung – Indonesia

²Department of Physics, Faculty of Mathematics and Natural Sciences,
University of Riau, Pekanbaru - Indonesia

*E-mail: warsito@fmipa.unila.ac.id

ABSTRACT

This paper presents the data acquisition system of water level measurements using short message service (SMS) gateway at frequency of Global System for Mobile communication (GSM) ranging from 900 MHz to 907.5 MHz. We use the HC-SR04 ultrasonic transducer with a frequency of 40 kHz and a measurement range up to 5 m for water level detection. The output of the water level measurement are shown in LCD monitor, stored in microSD, and transferred to mobile phone by SMS gateway system. The data transmission using SMS gateway is realized using two models, namely the scheduled and requested transmission. The analysis of the data transmission using SMS gateway shows the time shift due to the transmission process for about 25 seconds. The modem processing time called the time-shift occurs due to the processing, transmission, and receiving data into information. To reduce this time-shift, we designed the commands in the program by creating and transmitting to a single information model. The average time reduction of time-shift decreases to about 4.15 seconds for 30 mobile phone number. The overall analysis of data acquisition system shows good results and efficient.

Keywords: *Data Acquisition, Water Level, Real Time, On Line, Sms Gateway*

1. INTRODUCTION

There are many studies that apply the internet and short message service (SMS) gateway for online and the real time data acquisition system. The time-shift in real time and online data acquisition system is the important parameter. It is inconvenient if we use the data acquisition system in long time period of measurement and also it is not suitable in early warning system [1]. Data acquisition and simulation of flood dispersion using Bayesian network model have been proposed and gives a better result with the precision of 0.992 [2].

The software development of SMS gateway system for general purposes [3 – 5] and for data acquisition has been developed [6 – 11]. The generic system of SMS gateway has been also developed for easily access to a data base system [3]. The architectural design of the SMS gateway system has been improved for the dissemination of

information for a lot of phone numbers and also for commercial purposes [4].

The health monitoring system using SMS gateway has also been developed [9]. If the value of patient health parameters being monitored has exceeded a certain threshold, the system sends an SMS to the server and an action will be carried out by the medicine team. The SMS control system can be checked in a database table saved in the computer server. If the message has been sent, it is sufficient to operate all instructions through the computer server. To verify that the message has been sent and received by the client of mobile phone number, it can also be accessed from the data base system using on-line internet system.

The data acquisition system using Global System for Mobile (GSM) module for measuring environmental parameters such as wind speed, temperature, and humidity have been developed [6], [10]. They have designed an instrument to

calculate the number of flies caught in traps; their instrument has 78.1% of accuracy. The data obtained is then stored in the data base system of the host control platform (HCP) and sent by using SMS to the destination telephone number [6]. The GSM system in data acquisition has been also widely used in monitoring the state of apparatus installed in remote areas, for example, the monitoring of a water pump system based on solar cells [7].

Monitoring and control of climate parameters for example temperature, humidity, and groundwater, in the greenhouse system can be done using SMS gateway system [8]. The development of integrated multi-sensor in the data transmission using the wireless system has been developed for monitoring the value of air pressure, humidity, and air temperature applied in Kenya [11]. The data storage system using a microSD and a computer server is done every 30 minutes, and the monitoring system in real time and online is shown using a web system. The synchronous acquisition method has been just developed in the DOS-CDMA scheme in Software Definable Radio Networks (SDRNs), and the computer simulation has shown a 95% reduction time of synchronous acquisition compared to the sliding correlation method [12].

The previous studies in the use of SMS gateway for the data acquisition system as described above [3 – 11], has not analyzed the efficiency associated with the time-shift required for sending and receiving SMS. Recently, the simulation by compressing the data has been improved in the application of the cognitive radio sensor networks with a view to ensure an increased throughput in a mobile environment [13]. Therefore, this research describes the analysis of time-shift required for transmitting the information data acquisition using SMS gateway system. The time-shift as a function of the recipient's mobile phone number will also be analyzed as well as methods to accelerate the delivery of information will be discussed.

2. MATERIALS AND METHODS

Figure 1 illustrates a schematic of realized hardware design and the realized circuit is shown in Figure 2. Firstly, the river water level is acquired using HC-SR04 ultrasonic transducer. The output of HC-SR04 ultrasonic transducer is connected to PB0 and PB1 of ATmega16 microcontroller port (marked ‘a’ in Figure 2). The ultrasonic transducer can measure water level up to 500 cm with a vertical resolution of 3 mm. The transducer still

provides a water level response appropriately for the angular angle between the ultrasonic transmitter and receiver up to 15°.

The calibration and linearization system of the ultrasonic transducer response is the segmentation linearization model, as we have previously realized [14].

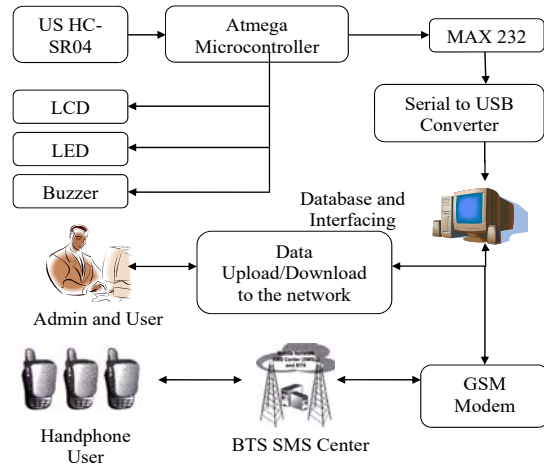

Figure 1: Design of Data Acquisition System Using SMS Gateway.

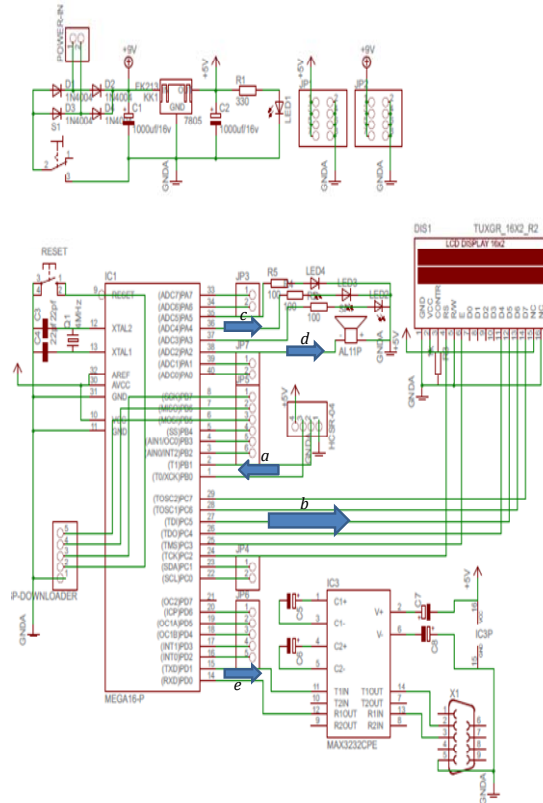

Figure 2: The Realized Circuit of System.

As shown in Figure 2, the principal signal output of microcontroller is connected to four signal outputs; displayed on the 16x2 LCD screen (marked by 'b'); LED indicator (marked by 'c'; buzzer (marked by 'd'); and connected to the server computer (marked by 'e'). The data are serially transferred to the computer server using USB serial communication system, and before we employ the MAX3232 IC for adapting to TTL voltage level. A Huawei E352 "modem" (modulator – demodulator) and MovimaxQ200 type are assembled to connect the computer server to internet and GSM network at ranged frequency from 900 MHz to 907.5 MHz.

The design of software in computer server is shown in Figure 3. The operating system of server computer is the Windows 7 Ultimate 32 bit Service Pack 1 OS and has three main programs:

- (i) the interfacing program for data acquisition using Visual Basic 6.0.

The program below is part of the program stored in the microcontroller to transmit water level data to the computer.

```
On Urxc Baca_serial
'Jika ada data serial masuk, baca sub baca_serial
Enable Urxc
Enable Interrupts
Loop
Baca_serial:
Disable Urxc
Disable Interrupts
Datas = Inkey()
Input Datas Noecho
'Baca input data serial
Dke = Mid(datas, 1, 1)
```

- (ii) the database program using MySQL,

To connect the driver interfacing application with the database storage media, MYSQL, then to connect between the two required a special program that must exist in the driver application program. In order for VB programming to connect with the MYSQL database must be added *library*. The library used is MySQL connector ODBC version 3.51.

- (iii) the web application and SMS system program.

This web application is built using the PHP programming language as well as XAMPP as its local host provider. The testing web system applications have been done using Mozilla Firefox applications that have been

installed on the computer. We can also use other browser applications, such as Internet Explorer, Google Chrome, Safari, etc. This test is done with two stages, namely testing web pages used by the user/client and web pages used by the administrator.

The data acquisition program is implemented using Visual Basic 6.0 compiler, while the PHP, MySQL, and Apache are used for the database program. For web design program, we use Adobe Dreamweaver CS5 program. The SMS gateway system has been realized by using Gammu 1.32.0 application.

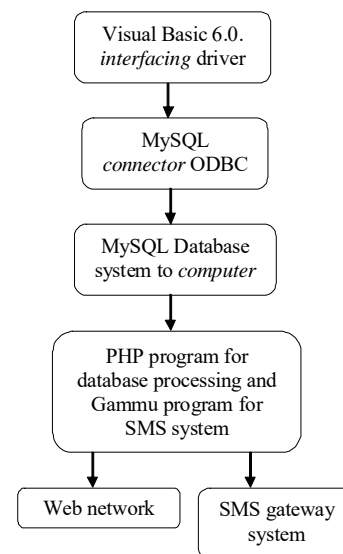

Figure 3: Flowchart of Software Design in Server Computer.

The Visual Basic (VB) 6.0. as interfacing driver has been programmed to manage data communication between the data acquisition hardware to the server computer. The routine of software implemented include the real time data of water level obtained by 40 kHz ultrasonic transducer type HC-SR04. The transducer of river water level has been clearly characterized and has 0.01 m resolution for 0 to 5 m measurement range [15].

3. RESULTS AND DISCUSSION

3.1. Interfacing and Data Base System

The USB port of computer server is used to receive a serial data controlled in 9600 of the transfer speed, while the transferred data has 8-bits data and completed by 1 bit of stop. To realize this

serial communication, the MScComm in VB is initially in enable position. In order to connect the MySQL database to the computer server, the library of VB must be added by using the MySQL ODBC connector version 3.51. The time delay for data retrieving and storing can be arranged in accordance with the purposes of the data processing.

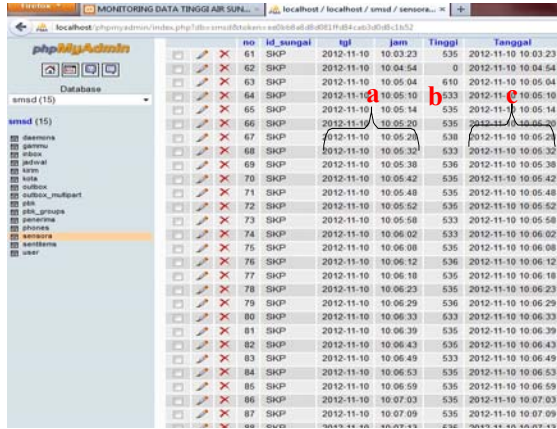

Figure 4: The Table View on MySQL Database.

Figure 4 presents the water level value, marked by “(b)” taken from MySQL database in computer server. The obtained principal data are the water level value acquired in real time. Using table in Fig. 3, the timing of receiving data, marked by “(a)” and the timing for data storage, marked by “(c)”, show the same value indicating that the data processing in the computer server is working in high speed less than 1 second. The storage data in the computer server will be actually the real data value shown in the web system and acquired for SMS gateway system. The storing system of water level value on micro SD is actually done every second and stored in the *.txt extension form, as shown in Figure 5.

NO	DATE	TIME	LEVEL (cm)
0148	2012/12/19	15:54:28	536
0149	2012/12/19	15:54:29	511
0150	2012/12/19	15:54:30	510
0151	2012/12/19	15:54:31	511
0152	2012/12/19	15:54:32	511
0153	2012/12/19	15:54:33	511
0154	2012/12/19	15:54:34	512
0155	2012/12/19	15:54:38	512
0156	2012/12/19	15:54:39	512
0157	2012/12/19	15:54:40	512
0158	2012/12/19	15:54:42	511
0159	2012/12/19	15:54:43	512
0160	2012/12/19	15:54:44	512
0161	2012/12/19	15:54:45	516
0162	2012/12/19	15:54:46	517
0163	2012/12/19	15:54:47	519

Figure 5: The Stored Data of Water Level Value in the MicroSD.

3.2. Analysis of Water Level Responses in Real Time and On Line System

We have performed the ultrasonic transducer characterization by using the calibrated water level measurement. We have compared the water level displayed on LCD with the real water level, as shown on Figure 6.

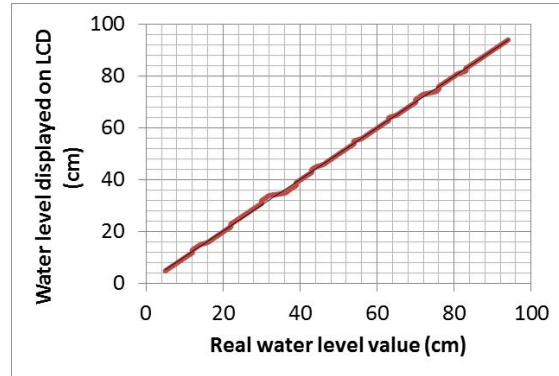

Figure 6: Calibration Graph of Ultrasonic Transducer.

The linear equation of realized transducer is given by this equation:

$$y = 0.9936x + 0.517 \quad (1)$$

We have stored the equation 1 in the microcontroller, in order to obtain the linear response of ultrasonic transducer.



Figure 7: Real Time and On Line Graph of River Water Level Displayed on the Client Computer.

Figure 7 is a real time graph of river water level monitoring shown in the client computer. On the monitoring page shows a graph of the apparent changes of river water level, which is the latest 40 data detected by the transducer. On the graph displays the status of the water level of the river, it is seen that the water level of the river is 535 cm with a secure status. The PHP program used to display the graph is as follows:

```
<p><p align="center" class="style2"></p>
<?php
```



```
Echo <font face=timesi size=5><a
href="http://localhost/alain/lihat
rekam.php?id=' . $kata . "'>Cetak</a>;
?>
<?php
$kata=$_GET['id'];
$hasil = "SELECT * FROM sensora WHERE tgl
= '$kata' order by jam desc";
$db_query = mysql_query($hasil) or
die("Query gagal");
```

3.3. Analysis of SMS Gateway System

For the data transmission system using SMS gateway, we have created a program on a server computer that serves for sending SMS to recipient's mobile phone number and recording the time of delivered data to inform that the data has been received. In this section, it will be analyzed two types of SMS gateway, firstly the scheduled SMS method and secondly, the requested SMS method.

In the admin menu, there are several additional pages, such as pages for manually recipient form of recipient data information via SMS, recipient list table information via SMS, pages containing incoming messages, outgoing messages and sent messages. The program used to create this form is as follows:

```
<Form id = "form1" name = "form1"
method = "post"
Action = "input_penerima.php">
```

The above program is a declaration of form types, form names and methods used and action when the form is executed. When the save button on the form is clicked, then the program will call the program input_penerima.php.

3.3.1. Scheduled SMS method

The SMS using the scheduled method is realized by sending the water level value at a specific time, such as every 5 minutes, every 1 hour, or each at 22:00:00 every day. The realized program has been given by using PHP program. Here's a principal routine of realized program to run the scheduled SMS method:

```
<html>
<head>
<!-- refresh script every 5 minutes -->
<meta http-equiv="refresh" content="300;
url=<?php $ _SERVER['PHP_SELF'];?>">
</head></html>
```

The realized coding is used to refresh the program proses.php every 300 seconds or 5 minutes, that means the data transmission via SMS gateway to the mobile phone number is done every 5 minutes. The delay of data transmission will be easily controlled by changing the value of refresh time.

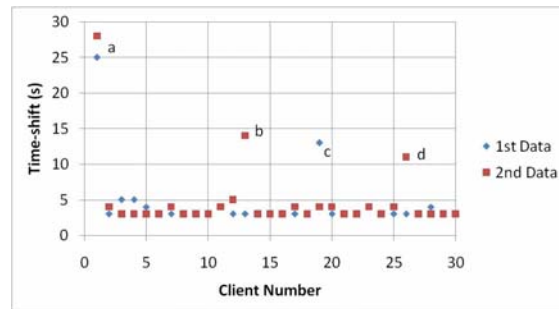

Figure 8: Delivery Time of Scheduled SMS.

The second principle program is then to check the speed of the system to send information to the recipient. This checking process is also destined to define the correctness of data between what has been sent to the recipient with the stored data in the database. To this purpose, we test the time needed to send an SMS using Huawei E352 modem, by sending an SMS to 30 mobile phones number of the recipient. The delivery time is shown in Figure 5.

Figure 8 shows the delivered time of SMS gateway system to all 30 mobile phone client number. In the Figure 8 (marked by 'a'), we know that the delivered time needed for the first phone number is too long, that is 25 s for the first data and 28 s for the second data. This time is actually needed by the program for running the routine process and auto refresh routine, after finishing this step the system needs just about 3s for every phone number. We find also there is too long time-shift due to an error modem process, for example marked by 'b', the time-shift is 14 s, also marked by 'c' and 'd' respectively 13 s and 11 s. As we understand that we need actually just 3 s for each mobile phone client number.

No	Client Phone Number	Date & Time	Content of Message
32	+62 812-7334-4622	2012-11-21 14:37:16	The water level of the Way Sekampung river on 2012-11-21 at 14:36:55 is: 539 cm.
33	+62 812-7334-4622	2012-11-21 14:42:15	The water level of the Way Sekampung river on 2012-11-21 at 14:41:55 is: 538 cm.

Figure 9: Sent-item in the Data Base System.

We have calculated the total time needed for the first data is about 121 seconds, starting at 14:35:08 and finishing at 14:37:19. At this time of testing,

we perform broadcast information delivery to the 30 client mobile phone number in twice repeating. So the average time of delivered time to the 30 recipient's number for first data is 4.03 s. The second data have been transmitted at 14:40:08, and finished at 14:42:32, hence the delivery time for the second data is 128 s, and the average delivered time is 4.26 s.

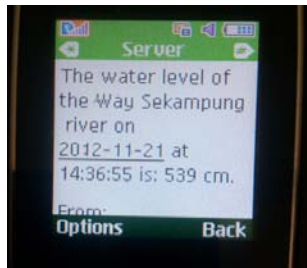

Figure 10: The Photo of Received SMS in the Client Phone Number Received from the Server.

Figure 9 shows the 'sentitem' table, while Figure 10 is an example of receiving SMS in phone number recipient. By regarding the time of SMS sending in Figure 10 (right red circle), that is at 14:36:55, then we look the time of receiving SMS in Figure 10 (left red circle) is 14:37:16, we know, that the time needed for transmitting the information is 21 seconds.

As outlined above, for sending data to the 30 mobile phone numbers takes more than 2 minutes, although the water level recorded per second. The water level value displayed on the SMS messages is actually retrieved from MySQL database. Therefore, it is possible there is different value between water level that has been recorded in the data base system and sent to the mobile phone number, because the data collection program on the database uses the data in the first 5 minutes that were taken by auto refresh process.

3.3.2. Requested SMS method

The second method of acquisition system by SMS gateway is given by requested SMS method. We can send a special text code SMS to server mobile phone number.

The text code format used to obtain the water level value is "HIGH #" and sent to the mobile phone center number. If the water level value has been found in accordance with the code of requested SMS, the computer server will send a message that contain water level value to intended mobile phone number. To analysis the results of SMS gateway system by request, we can check the "sentitem" in computer server.

Table 1: Time-shift of Receiving SMS by Request Method.

Time for incoming SMS	Received Messages	Time for responding SMS	Content of messages	Time-shift (s)
2012-11-21 22:51:21	HIGH#SKP	2012-11-21 22:51:42	The water level of the Way Sekampung river on 2012-11-21 at 22:51:21 is: 539 cm.	21
2012-11-21 22:51:50	HIGH#SKP	2012-11-21 22:53:32	The water level of the Way Sekampung river on 2012-11-21 at 22:51:50 is: 537 cm.	104
2012-11-21 22:51:59	HIGH#SKP	2012-11-21 22:52:19	The water level of the Way Sekampung river on 2012-11-21 at 22:51:59 is: 536 cm.	20
2012-11-21 22:52:03	HIGH#SKP	2012-11-21 22:53:27	The water level of the Way Sekampung river on 2012-11-21 at 22:52:03 is: 536 cm.	84
2012-11-21 22:52:08	HIGH#SKP	2012-11-21 22:53:22	The water level of the Way Sekampung river on 2012-11-21 at 22:52:08 is: 537 cm.	74

The time required for server computer replay automatically the SMS request is shown in Table 1. The data is obtained from the inbox table and sent item table in the server computer. In Table 1, we can analyze the time when the message was received by the system and when the message is sent by the system to the mobile phone number that is requesting data. We note for example, the second SMS has been received at 22:52:50, and the system responds to the mobile phone number at 22:53:32. We understand that the total time needed for refreshing process is 104 s with the value of water level is 537 cm. We know that it's actually possible at 22:53:32, the water level value is not 537 cm. In the table 2, we can also see the time needed to respond to the entering messages into the system, the fastest time was about 20 s and the longest time is of 104 s.

The time required for the server computer reply automatically SMS request is shown in Table 1. The data is obtained from the inbox table and sent item table in the server computer. In Table 1, we can analyze the time when the message was received by the system and when the message is sent by the system to the mobile phone number that is requesting data. We note for example, the second SMS has been received at 22:52:50, and the system responds to the mobile phone number at 22:53:32. We understand that the total time needed for refreshing process is 104 s with the value of water level is 537 cm. We know that it's actually possible at 22:53:32, the water level value is not 537 cm. In the table 2, we can also see the time needed to respond to the entering messages into the system, the fastest time was about 20 s and the longest time is of 104 s.

The time needed for responding the incoming SMS messages depends firstly on the number of messages that accumulate in the computer server outbox, and secondly, on the duration of a modem to the process executing. At this stage, we are sending an SMS to 10 mobile phone numbers that requests water level information.

4. CONCLUSION

Data acquisition system using SMS gateway can be realized by scheduled SMS system and requested SMS system. We have successfully managed to reduce the time-shift between sending and receiving SMS by simplifying the program in computer server. The scheduled SMS requires a longer time to send a message to 30 mobile phone number of about 2 minutes. For requested SMS, the response speed of the system for replying depends

on the number of SMS requests are processed within the system. If the SMS requests more than 15 phone number, the system will require about 4.15 s for such SMS. The decreasing of time required for data acquisition and data transmission is the result of the program design of our SMS gateway system.

ACKNOWLEDMENT

The authors thank the Directorate General of Higher Education, Ministries of Research, Technology, and Higher Education Republic of Indonesia which has given financial support to this research, project number: 78/UN26/8/LPPM/2016.

REFERENCES

- [1] Jirapon Sunkpho and Chaiwat Ootamakorn, "Real-time flood monitoring and warning system", *Songklanakar J. Sci. Technol.* 33 (2), 2011, pp. 227 – 235.
- [2] Nor Idayu Ahmad Azami, Nooraini Yusoff, Ku Ruhana Ku-Mahamud, "Data acquisition and discretization for flood correlation model" *Journal of Theoretical and Applied Information Technology*, Vol.95. No 4, 2017, pp. 879 – 889.
- [3] Muhammad Saleem and Kyung-Goo Doh, "Generic Information System Using SMS Gateway", *Fourth International Conference on Computer Sciences and Convergence Information Technology*, 2009, pp. 861 – 866. DOI: 10.1109/ICCIT.2009.99
- [4] Veena K. Katankar and V.M. Thakare, "Short Message Service using SMS Gateway", *International Journal on Computer Science and Engineering* Vol. 02, No. 04, 2010, pp. 1487-1491.
- [5] Bradley Reaves, Nolen Scaife, Dave Tian, Logan Blue, Patrick Traynor, and Kevin R.B. Butler, "Sending out an SMS: Characterizing the Security of the SMS Ecosystem with Public Gateways", *IEEE Symposium on Security and Privacy*, 2016; pp. 339 – 356. DOI: 10.1109/SP.2016.28.
- [6] Joe-Air Jiang, Chwan-Lu Tseng, Fu-Ming Lu, En-Cheng Yang, Zong-Siou Wu, Chia-Pang Chen, Shih-Hsiang Lin, Kuang-Chang Lin, and Chih-Sheng Liao, "A GSM-based remote wireless automatic monitoring system for field information: A case study for ecological monitoring of the oriental fruit fly, *Bactrocera dorsalis* (Hendel)", *Computers and*

- Electronics in Agriculture*, 62, 2008, pp. 243–259. DOI:10.1016/j.compag.2008.01.005.
- [7] Ammar Mahjoubi, Ridha Fethi Mechlouch and Ammar Ben Brahim, “A Low Cost Wireless Data Acquisition System for a Remote Photovoltaic (PV) Water Pumping System”, *Energies*, Vol. 4, 2011, pp. 68-89. DOI:10.3390/en4010068.
- [8] A. Rahali , M. Guerbaoui, A. Ed-dahhak, Y. El Afou, A. Tannouche, A. Lachhab, and B. Bouchikhi, “Development of a data acquisition and greenhouse control system based on GSM”, *International Journal of Engineering, Science and Technology* Vol. 3, No. 8, 2011, pp. 297-306. DOI:10.4314/ijest.v3i8.23.
- [9] Marko Hassinen, Maija Marttila-Kontio, Mikko Saesmaa, and Heli Tervo, “Secure Two-Way Transfer of Measurement Data”, *International Journal of Network Security*, Vol.6, No.1, 2008, pp.53–59.
- [10] Vandana Pandya and Deepali Shukla, “GSM Modem Based Data Acquisition System”, *International Journal Of Computational Engineering Research*, Vol. 2 Issue.5, 2012, pp. 1662 – 1667
- [11] Muthoni Masinde and Antoine Bagula, “A Calibration Report for Wireless Sensor-Based Weatherboards”, *J. Sens. Actuator Netw.* 4, 2015, pp. 30-49. doi:10.3390/jsan4010030.
- [12] Hajime Yamasaki, Takeshi Higashino, Katsutoshi Tsukamoto, and Shozo Komaki, “Fast synchronous acquisition method using chaos DOS-CDMA in software definable radio networks”, *IEICE Electronics Express*, Vol. 3, No.8, 2006, pp. 172 – 177. DOI: 10.1587/elex.3.172.
- [13] Janani S., Ramaswamy M. and Samuel Manoharan, J., “Clustered heed based data transfer strategy for cognitive radio sensor networks”, *ARPJ Journal of Engineering and Applied Sciences*, Vol. 11, No. 21, 2016, pp. 12631 – 12642.
- [14] Warsito, SW Suciayati, Gurum AP, Berli L. Putra, Sisca Aprila, and Laila Kurniati, “Calibration and Digital Linearization of Ultrasonic Transducer Response”, *Sensors & Transducers*, Vol. 183, Issue 12, 2014, pp. 48 – 52.
- [15] Warsito, SW Suciayati, Gurum AP and K Imaniar, “Study of inclination angle of reflector object in simple water level instrument using 40 kHz ultrasonic transducer”, *Journal of Theoretical and Applied Information Technology*, Vol 42 No 1, 2012, pp. 26 – 30.